

Online Data Sheet

Encoder WDGA 58A CANopen galv. isolation

www.wachendorff-automation.com/wdga58acangalv

Wachendorff Automation

... systems and encoders

- Complete systems
- Industrial rugged encoders to suit your application
- Standard range and customer versions
- Maximum permissible loads
- 48-hour express production
- Made in Germany
- Worldwide distributor network

Encoder WDGA 58A absolute CANopen galv. isolation, magnetic, with EnDra®- Technology



EnDra®
Technologie

CANopen®

- EnDra®: maintenance-free and environmentally friendly
- CANopen, Single- and Multiturn
- Galvanic isolation
- Communication Profile according to CiA 301
- Device Profile for encoder CiA 406 V3.2 class C2
- Single-/Multiturn (14 bit/39 bit)
- Forward-looking technology with 32 Bit processor
- 2-colour-LED as indicator for operating condition and error message appropriate CiA 303-3
- High shaft load up to 220 N radial, 120 N axial

www.wachendorff-automation.com/wdga58acangalv

Mechanical Data	
Housing	
Flange	synchro flange
Flange material	aluminium
Housing cap	steel case chrome-plated, magnetic shielding
Housing	Ø 58 mm
Shaft(s)	
Shaft material	stainless steel
Starting torque	approx. 1 Ncm at ambient temperature, approx. 1.416 in-ozf at ambient temperature
Shaft	Ø 6 mm
Shaft length	L: 12 mm
Max. Permissible shaft loading radial	125 N
Max. Permissible shaft loading axial	120 N
Shaft	Ø 8 mm
Shaft length	L: 20 mm
Max. Permissible shaft loading radial	125 N
Max. Permissible shaft loading axial	120 N
Shaft	Ø 10 mm
Shaft length	L: 20 mm
Max. Permissible shaft loading radial	220 N
Max. Permissible shaft loading axial	120 N
Shaft	Ø 3/8", 9.525 mm, Ø 3/8"
Shaft length	L: 20 mm, L: 0.787 in
Max. Permissible shaft loading radial	220 N, 22.434 kp
Max. Permissible shaft loading axial	120 N, 12.237 kp
Bearings	
Bearings type	2 precision ball bearings
Nominal service life	1 x 10 ⁹ revs. at 100 % rated shaft load 1 x 10 ¹⁰ revs. at 40 % rated shaft load 1 x 10 ¹¹ revs. at 20 % rated shaft load
Max. operating speed	8000 rpm

Electrical Data	
Power supply/Current consumption	10 VDC up to 32 VDC: max. 100 mA
Power consumption	max. 1 W
Sensor data	
Singleturn technology	innovative hall sensor technology
Singleturn resolution	16,384 steps/360° (14 bit)
Singleturn accuracy	< ±0.35°
Singleturn repeat accuracy	< ±0.20°
Intern cycle time	600 µs
Multiturn technology	patented EnDra® technology no battery and no gear.
Multiturn resolution	up to 262,144 revolutions (18 bit) with high precision value up to 39 bit.
Environmental data	
ESD (DIN EN 61000-4-2):	8 kV
Burst (DIN EN 61000-4-4):	2 kV
includes EMC:	DIN EN 61000-6-2 DIN EN 61000-6-3
Vibration: (DIN EN 60068-2-6)	50 m/s ² (10 Hz up to 2000 Hz)
Shock: (DIN EN 60068-2-27)	1000 m/s ² (6 ms)
Design:	according DIN VDE 0160
Turn on time:	<1,5 s
Interface	
Interface:	CAN
Protocol:	CANopen <ul style="list-style-type: none"> • Communication profil CiA 301 • Device Profile for encoder CiA 406 V3.2 class C2
Node number:	1 up to 127 (default 127)
Baud rate:	50 kBaud up to 1 MBaud with automatic bit rate detection.
Advice:	The standard settings as well as any customization in the software can be changed via LSS (CiA 305) and the SDO protocol, e. g. PDOs, Scaling, Heartbeat, Node-ID, Baud rate, etc.

Programmable CAN transmission modes:	Synchronous mode: when a synchronisation telegram (SYNC) is received from another bus node, PDOs are transmitted independently. Asynchronous mode: a PDO message is triggered by an internal event. (e.g. change of measured valued, internal timer, etc.)
---	---

General Data

Connections	connector outlet
Protection rating (EN 60529)	IP67, shaft sealed to IP65
Operating temperature	-40 °C up to +85 °C, -40 °F up to +176 °F
Storage temperature	-40 °C up to +100 °C, -40 °F up to +212 °F

More Information

General technical data
<http://www.wachendorff-automation.com/gtd>

Options
<http://www.wachendorff-automation.com/acc>

WDGA 58A CANopen, galv. isolation, with M12x1, axial CB5, 5-pin

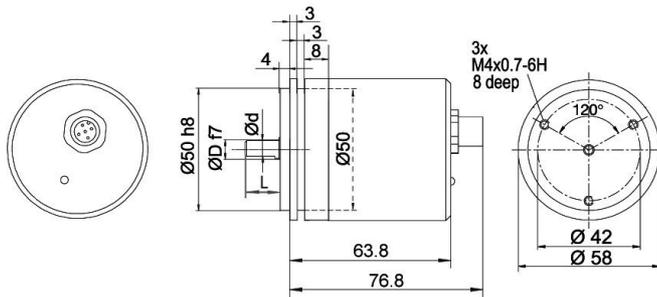

D = 6, L = 12, d = 5.3 shaft with flat
 D = 8, L = 20, d = 7.5 shaft with flat
 D = 10, L = 20, d = 10 shaft with out flat*
 D = 3/8", L = 20, d = 8.3 shaft with flat
 *option full IP67 version: D=Ø 10 mm)
 D = 10, L = 20, d = 9 shaft with flat

Description

CB5 axial, 5-pin, shield connected to encoder housing

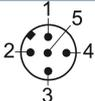
Assignments	
	CB5 
(+) Vcc	2
GND	3
CANHigh	4
CANLow	5
CANGND shield	1

WDGA 58A CANopen, galv. isolation, M12x1, CC5, radial, 5-pin

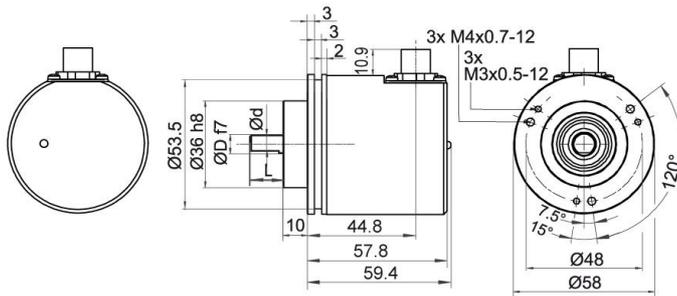

- D = 6, L = 12, d = 5.3 shaft with flat
- D = 8, L = 20, d = 7.5 shaft with flat
- D = 10, L = 20, d = 10 shaft with out flat*
- D = 3/8", L = 20, d = 8.3 shaft with flat
- *option full IP67 version: D=Ø 10 mm)
- D = 10, L = 20, d = 9 shaft with flat

Description

CC5 radial, 5-pin, shield connected to encoder housing

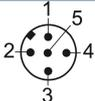
Assignments	
	CC5 
(+) Vcc	2
GND	3
CANHigh	4
CANLow	5
CANGND shield	1

WDGA 58A CANopen, galv. isolation, with 2x M12x1, axial DB5

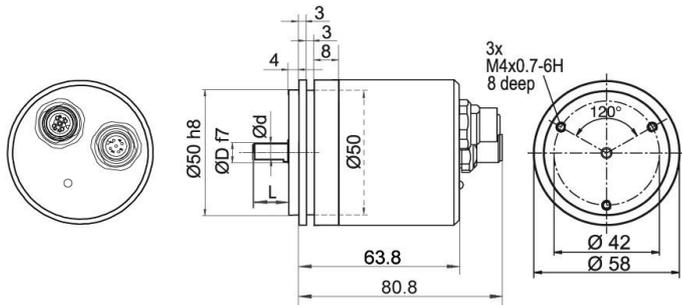

D = 6, L = 12, d = 5.3 shaft with flat
 D = 8, L = 20, d = 7.5 shaft with flat
 D = 10, L = 20, d = 10 shaft with out flat*
 D = 3/8", L = 20, d = 8.3 shaft with flat
 *option full IP67 version: D=Ø 10 mm)
 D = 10, L = 20, d = 9 shaft with flat

Description

DB5 axial, 5-pin, shield connected to encoder housing

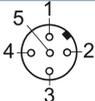
Assignments	
	DB5 
Female connector	M12x1, 5-pin
(+) Vcc	2
GND	3
CANHigh	4
CANLow	5
CANGND shield	1

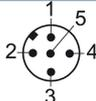
Assignments	
	DB5 
Connector	M12x1, 5-pin
(+) Vcc	2
GND	3
CANHigh	4
CANLow	5
CANGND shield	1

Options

120 Ohm terminating resistor

Order key

The encoder WDGA 58A CANopen galv. is also available with fixed 120 Ohm terminating resistor.

AEO

Shafts sealed to IP67 (shaft with flat: Ø 10 mm only)

Order key

The encoder WDG 58A CANopen galv. isolation can be supplied in a full IP67 version.

AAS

Max. RPM: 3500 min⁻¹

Permitted Shaft-Loading: axial 100 N; radial 110 N

Starting-torque: approx. 4 Ncm at ambient temperature

Example Order No.	Type	Your encoder
WDGA 58A	WDGA 58A	WDGA 58A
	Shaft	Order key
06	Ø 6 mm	06
	Ø 8 mm	08
	Ø 10 mm	10
	Ø 3/8", 9.525 mm Ø 3/8"	4Z
	Singleturn Resolution	Order key
12	Singleturn resolution 1 Bit up to 14 Bit: (e. G. 12 Bit)	12
	Multiturn Resolution	Order key
18	Multiturn-resolution: (examples) 18 bit = 18 39 bit = 39 no Multiturn = 00	18
	Data protocol	Order key
CO	CANopen (galv. isolation)	CO
	Software	Order key
A	up to date release	A
	Code	Order key
B	binary	B
	Power supply	Order key
0	10 V up to 32 V (standard)	0
	Galvanic isolation	Order key
1	yes	1
	Electrical connections	Order key
CB5	Connector:	
	sensor-connector, M12x1, 5-pin, axial, IP67, shield connected to encoder housing	CB5
	sensor-connector, M12x1, 5-pin, radial, IP67, shield connected to encoder housing	CC5
	sensor-connector/female connector, 2x M12x1, 5-pin, axial, IP67, shield connected to encoder housing	DB5
	Options	Order key
	Without option	Empty
	120 Ohm terminating resistor	AEO
	Shafts sealed to IP67 (shaft with flat: Ø 10 mm only)	AAS

Example Order No.	WDGA 58A	06	12	18	CO	A	B	0	1	CB5	
--------------------------	----------	----	----	----	----	---	---	---	---	-----	--

WDGA 58A											Example Order No.
----------	--	--	--	--	--	--	--	--	--	--	--------------------------



For further information please contact our local distributor.
Here you find a list of our distributors worldwide.
http://www.wachendorff-automation.com/distributors_worldwide.html



Wachendorff Automation GmbH & Co. KG
Industriestrasse 7 • D-65366 Geisenheim

Phone: +49 67 22 / 99 65 25
Fax: +49 67 22 / 99 65 70
E-Mail: wdg@wachendorff.de
www.wachendorff-automation.de

