

Distance sensors

OADM 20S4481/S14F

dimension drawing

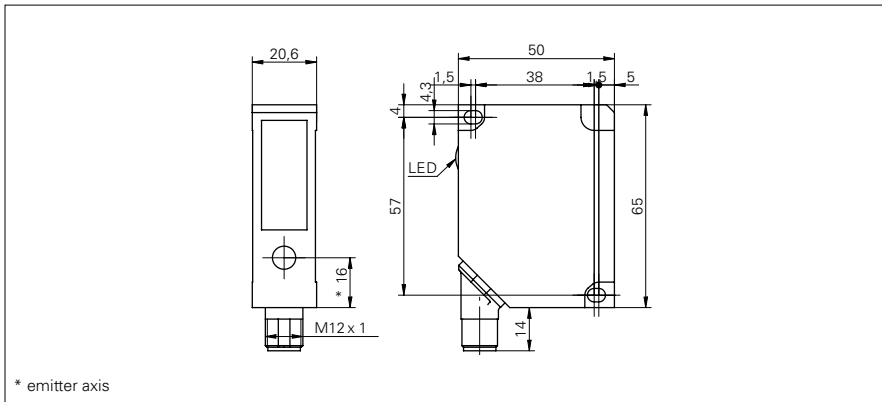

general data

measuring distance Sd	200 ... 1000 mm
adjustment	no
power on indication	LED green
soiled lens indicator	LED red
resolution	0,6 ... 2,5 mm
linearity error	± 2,4 ... ± 10 mm
light source	pulsed red laser diode
wave length	650 nm
laser class	2
beam type	point
beam diameter	2 mm
temperature drift	< 0,06 % Sde/K

electrical data

response time / release time	< 10 ms
voltage supply range +Vs	12 ... 28 VDC
current consumption max. (no load)	100 mA
output circuit	RS 485
baud rate	19200
output current	< 100 mA
alarm output	push-pull
short circuit protection	yes
reverse polarity protection	yes, Vs to GND

mechanical data

width / diameter	20,6 mm
height / length	65 mm
depth	50 mm
type	rectangular
housing material	die-cast zinc
front (optics)	glass
connection types	connector M12 8 pin, rotatable

photo



connection diagram

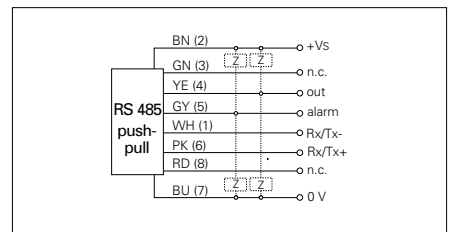

laser warning

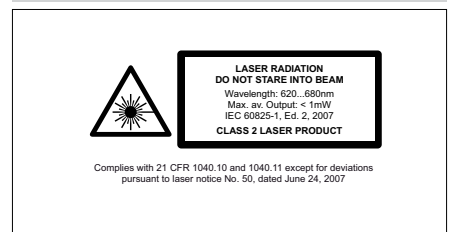

Distance sensors**OADM 20S4481/S14F****ambient conditions**

ambient light immunity	< 3 kLux
operating temperature	0 ... +50 °C
protection class	IP 67