

**BOURDON**  
The Original by Baumer



## Main Features

- Excellent repeatability
- Dead band adjustment for regulation
- Fix dead band for control and alarm
- High over pressure resistant

## Applications

- Power generation safety equipment
- Pressurized chambers control
- Liquid level control

## Technical Data

Pressure range	-50 mbar ... 0 to 0 ... 2500 mbar	Electrical connection	Terminal block with plastic cable gland for Ø 7 to 10.5 mm
Temperature	Process : -15 ... +150°C Ambient : -25 ... +70°C Storage : -40 ... +70°C	Electrical function	See ordering code details on page 5
Repeatability	± 1% F.S. @ constant pressure cycle	Adjustment	2 external adjustment screws on top of the case for set point and dead band
CE conformity	Low Voltage Directive LVD 2006/95/EC Pressure Equipment Directive PED 97/23/EC		
Protection rating	IP 66 (EN 60529)		
Process Connection	Stainless steel 1.4404 (316L)		
Sensing element	Flanges : Stainless steel 1.4404 (316L) Diaphragm : Viton®		
Scale	Internal. Accuracy on reading ± 5% FS		
Cover	Zamak blue painted Captive stainless steel screws		
Case	Black Zamak		
Mounting	Wall mounting braket		
Ground connection	Via internal terminal block		

## Options

Customer specific set point adjustment	Code SETP
Oxygen application	Code 0765
Mounting on 2" pipe	Code 0407
Electrical connection : stainless steel connector (Souriau)	Code 2298
Mobile plug for stainless steel connector (Souriau)	Code 2249
Stainless steel tag plate and wire	Code 9941
Lead seal of the adjustment screws	Code 8990

## Principle

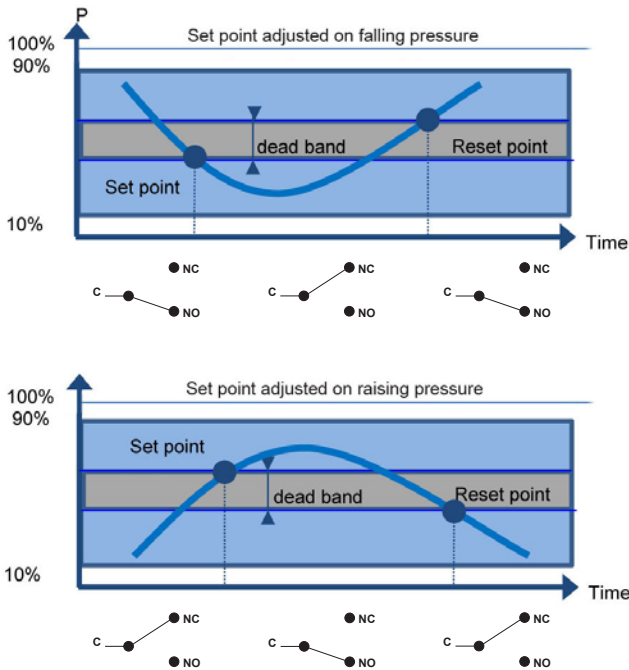

A flexible sensing element actuates a microswitch by means of a lever. The set point is adjusted by means of a compressible spring installed in opposition.

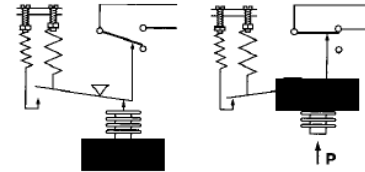

Set point and reset point must be between 10% and 90% of the selected scale.

### Standard factory adjustment

Setpoint at 50% of the scale on falling pressure

### Customer specific factory adjustment (option SETP)

The following specifications have to be given with the order:

- Setpoint value
- Adjustment on falling or raising pressure
- Dead band value when using an adjustable dead band switch

## Electrical connections

### 1 SPDT

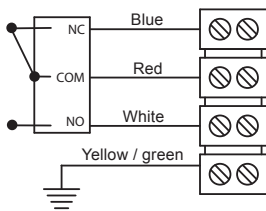

### 2 SPDT

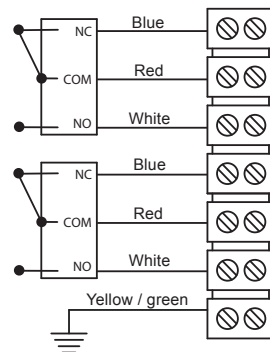

## Micro switches characteristics

Switch code	N (T)	A (B)	M (K)	C (W)	E (F)	H	D (V)	J
Type	Tropicalized	Standard	Gold contact	Hermetic	Ultra sensitive	Manual reset	Ultra sensitive Hermetic	Manual reset
6 Vdc	0.1 ... 8 A	0.4 ... 15 A	10 ... 50 mA	5 mA ... 4 A	0.4 ... 1 A	N/A	0.4 ... 4 A	N/A
12 Vdc	0.1 ... 8 A	0.4 ... 15 A	10 ... 50 mA	5 mA ... 4 A	0.4 ... 1 A	N/A	0.4 ... 4 A	N/A
24 Vdc	0.1 ... 8 A	0.4 ... 6 A	10 ... 50 mA	5 mA ... 4 A	0.4 ... 1 A	0.1 ... 8 A	0.4 ... 4 A	0.1 ... 8 A
30 Vdc	0.1 ... 8 A	0.4 ... 6 A	10 ... 10 mA	5 mA ... 3 A	0.4 ... 1 A	0.1 ... 8 A	0.4 ... 2 A	0.1 ... 8 A
48 Vdc	0.1 ... 8 A	0.4 ... 6 A	10 ... 50 mA	5 mA ... 3 A	N/A	0.1 ... 8 A	N/A	0.1 ... 8 A
110 Vdc	N/A	0.1 ... 0.5 A	10 ... 50 mA	5 mA ... 1 A	N/A	N/A	N/A	N/A
220 Vdc	N/A	0.1 ... 0.25 A	10 ... 50 mA	5 mA ... 0.5 A	N/A	N/A	N/A	N/A
115 Vac	0.1 ... 10 A	0.4 ... 15 A	10 ... 50 mA	50 mA ... 3 A	0.4 ... 10 A	0.1 ... 10 A	N/A	0.1 ... 10 A
250 Vac	0.1 ... 5 A	0.2 ... 15 A	10 ... 100 mA	50 mA ... 2.5 A	0.2 ... 10 A	0.1 ... 5 A	N/A	0.1 ... 5 A
Dielectric rigidity between contacts and ground	2000 V	2000 V	2000 V	1500 V	2000 V	2000 V	1000 V	2000 V

## Adjustable ranges

Scale	P. Max accidental	Code	Micro-switch dead band <sup>1)</sup>								
			Adjustable dead band				Fixed dead band				
			N (T*)	A (B*)	M (K*)	C (W*)		E (F*)		H	D (V*)
mbar	bar		10%	90%	10%	90%	10%	90%	10%	90%	
mbar											
-50 ... 0	10	101	2 - 25	2.5 - 25	6.5 - 25	7.5 - 25	0.6	0.6	2.5	3	
-2 ... 10	10	102	1 - 10	1 - 10	4.5 - 10	4.5 - 10	0.4	0.4	1.5	1.5	
-5 ... 50	10	103	1 - 20	2 - 20	4.5 - 20	5 - 20	0.4	0.4	1.5	2.5	
-8 ... 100	10	104	1.5 - 25	2.5 - 25	5 - 25	10 - 25	0.5	0.5	2	3	
-200 ... 0	50	151	12 - 80	20 - 80	25 - 80	40 - 80	3	4	14.5	25	
0 ... 200	50	152	15 - 80	25 - 80	30 - 80	45 - 80	3.5	4	18	30	
0 ... 400	50	153	17 - 150	30 - 150	35 - 150	50 - 150	4	5.5	20.5	35	
0 ... 1000	50	154	22 - 150	35 - 150	45 - 150	60 - 150	6	7	26.5	45	
0 ... 700	100	171**	20 - 350	40 - 350	40 - 350	70 - 350	7	9	24	50	
0 ... 1500	100	172**	20 - 350	60 - 350	40 - 350	100 - 350	7	9	24	75	
0 ... 2500	100	173**	25 - 350	90 - 350	50 - 350	160 - 150	9	11	30	110	

(\*) When using 2 microswitches dead band lower values should be x1.5

(\*\*) G1/4 female only

<sup>1)</sup> The value of the dead band is depending on the value of the set point.

This table contains the dead band values for set point adjustment at 10% and 90% of the selected scale. For adjustable dead band the lower value corresponds to the dead band spring totally released and the higher corresponds to the dead band spring fully tensed. For other set points the dead band value can be calculated by linear interpolation between the values at 10% and 90%.

**Dimensions (mm)**

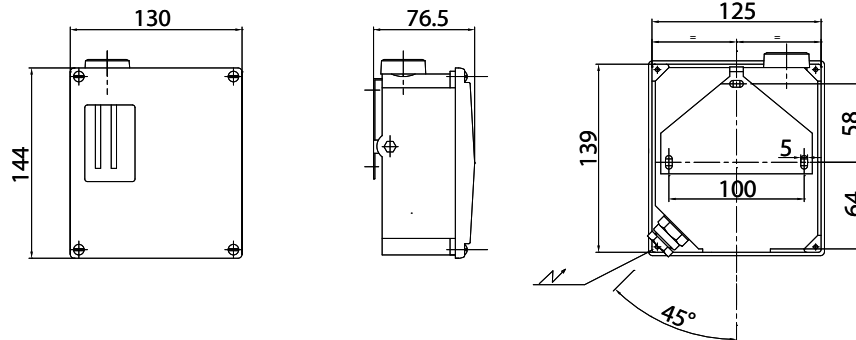

Pressure range codes : 101 - 102 - 103 - 104  
Weight : 10 kg

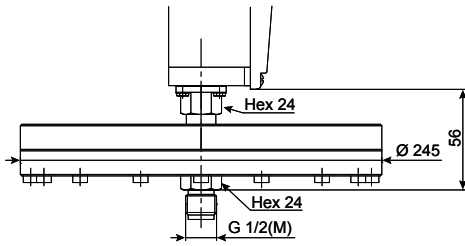

Pressure range codes : 151 - 152 - 153 - 154  
Weight : 6.4 kg

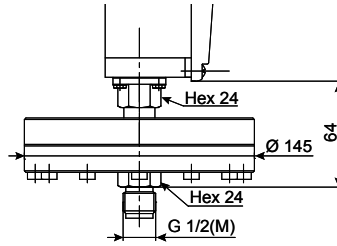

Pressure range codes : 171 - 172 - 173  
Weight : 7 kg

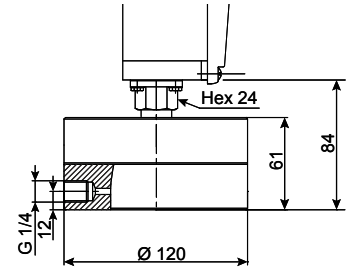

## Ordering details RPHN

	RP	HN	-	A	.	xxx	/
<b>Model</b>							
Industrial pressure switch with high overpressure resistance	RP						
<b>Approvals</b>							
Standard version without ATEX approval		HN					
			-				
<b>Type of micro switches</b>							
<b>Deadband</b>							
1 SPDT standard changeover switch				Adjustable		A	
2 SPDT standard changeover switch				Adjustable		B	
1 SPDT hermetically changeover switch				Adjustable		C	
2 SPDT hermetically changeover switch				Adjustable		W	
1 SPDT ultra sensitive changeover switch				Fix		E	
2 SPDT ultra sensitive changeover switch				Fix		F	
1 SPDT hermetically, ultra sensitive changeover switch				Fix		D	
2 SPDT hermetically, ultra sensitive changeover switch				Fix		V	
1 SPDT gold contact changeover switch				Adjustable		M	
2 SPDT gold contact changeover switch				Adjustable		K	
1 SPDT tropicalized changeover switch				Adjustable		N	
2 SPDT tropicalized changeover switch				Adjustable		T	
1 SPDT changeover switch, manual reset, opening on raising pressure				Fix		H	
1 SPDT changeover switch, manual reset, opening on falling pressure				Fix		J	
Pneumatic changeover contact, NO						Z	
Pneumatic changeover contact, NC						Y	
<b>Type</b>							
Standard						A	
<b>Process connection</b>							
G 1/4 female (only pressure ranges 171, 172, 173)							H
G 1/2 male (standard)							3
1/2 NPT male							6
1/4 NPT female							8
<b>Pressure range (mbar)</b>							
<b>Pressure range (kPa)</b>							
-50 ... 0							101
-2 ... 10							102
-5 ... 50							103
-8 ... 100							104
-200 ... 0							151
0 ... 200							152
0 ... 400							153
0 ... 1000							154
0 ... 700							171
0 ... 1500							172
0 ... 2500							173
							Process connection G1/4 female
							Process connection G1/4 female
							Process connection G1/4 female

Options to be added behind the / (see example below)

## Ordering example with options

